



A novel method for measuring the focal point of a sagittal-focusing Laue crystal monochromator

Jiaowang Yang,^{a,b} Weifan Sheng,^{a,b} Xu Liu,^a Lingfei Hu^a and Quan Cai^{a*}

^aBeijing Synchrotron Radiation Facility, Institute of High Energy Physics, Chinese Academy of Sciences, 19B Yuquan Road, Shijingshan District, Beijing 100049, People's Republic of China, and ^bSchool of Physical Sciences, University of Chinese Academy of Sciences, 19A Yuquan Road, Shijingshan District, Beijing 100049, People's Republic of China.
 *Correspondence e-mail: caiq@ihep.ac.cn

Received 7 March 2019

Accepted 14 July 2019

Edited by A. Momose, Tohoku University, Japan

Keywords: sagittally bent double-Laue monochromator; focal point size; multi-hole arrays; ray-tracing measurements.

In order to overcome space limitations, a novel method is introduced to measure the focal point size of a sagittally bent Laue crystal monochromator by using a multi-hole array. Combined with ray-tracing measurements, the focal length and focused beam size were determined. Theoretical simulations and experiments were performed to demonstrate the feasibility of this method. The experimental results show that this method can provide a fast way of measuring the focusing characteristics of a sagittally bent Laue crystal monochromator.

1. Introduction

X-ray focusing is helpful for obtaining a small beam size with high flux. In the field of X-ray optics, horizontal focusing with sagittally bent crystals has long been an efficient method for focusing synchrotron X-rays. Zhong *et al.* (2001*a,b*) proposed using asymmetric sagittally bent Laue crystals to focus high-energy X-rays. For measuring the beam size, a test beamline is normally necessary, which has a long hutch to contain the focal point. In some cases, however, the focal length of the monochromator is too long for the hutch, even if the crystal is bent to a smaller radius of curvature.

Here we introduce a novel method for measuring the focusing characteristics of a sagittally bent double-Laue monochromator (DLM) by using a multi-hole array with a series of equidistant circles used for dividing the incident beam into several pencil beams in the horizontal direction. A CCD was placed downstream of the DLM to record the divided reflecting beam spots at various distances. Combined with ray-tracing measurements, the focal length and focused beam size could be determined.

2. Ray-tracing simulation

The sagittally bent DLM was designed at the Beijing Synchrotron Radiation Facility (BSRF) to provide high-energy X-rays from 60 keV to 120 keV in future light sources. A schematic of the DLM configuration is shown in Fig. 1. The distance between the two monochromator crystals was 808 mm, the sagittal radii of the two bent crystals were set to 1.2 m and the DLM worked at 80 keV.

Ignoring the distance between the two bent crystals, the sagittal focal length of the DLM is given by (Zhong *et al.* 2001*a,b*)

$$\frac{1}{F_1} + \frac{1}{F_2} = \frac{2 \sin \theta_B \sin \chi}{R_{s1}} + \frac{2 \sin \theta_B \sin \chi}{R_{s2}}, \quad (1)$$

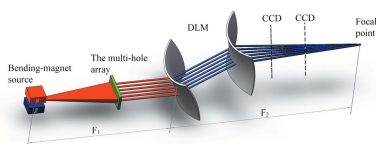

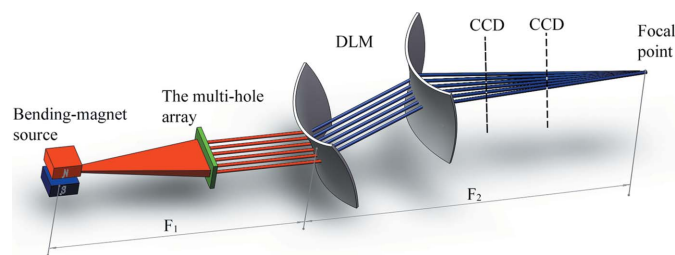

Figure 1
Schematic of the DLM configuration.

where F_1 is the distance between the source (39 m) and the DLM, F_2 is the distance between the DLM and the focal point, R_{s1} is the sagittal radius of the first crystal, R_{s2} is the sagittal radius of the second crystal, θ_B is the Bragg angle ($\theta_B = 1.42^\circ$ at 80 keV) and χ is the asymmetry angle ($\chi = 35.3^\circ$) defined as the angle between the crystal surface normal and the reflection plane.

The focusing characteristics of the sagittally bent DLM were simulated by the ray-tracing software *XRT* (Klementiev & Chernikov, 2014). The sagittally bent Laue crystals were simulated according to dynamical theory (Shi *et al.*, 2013). The sagittally bent crystals used in this simulation were rectangular in shape with a thickness of 0.65 mm. The crystal surfaces were in the (100) direction and the diffraction plane was parallel to the (111) plane. The X-ray beam generated by the BL09B beamline of the Shanghai Synchrotron Radiation Facility (SSRF) at 80 keV is predefined by a fixed aperture of $0.4 \text{ mrad} \times 0.025 \text{ mrad}$. Fig. 2 shows the beam size dimensions simulated at the focus position (45.6 m from the first crystal) by the DLM at 80 keV. In the horizontal plane, the beam is focused to a Gaussian-shaped profile with a full width at half-maximum (FWHM) of 0.125 mm.

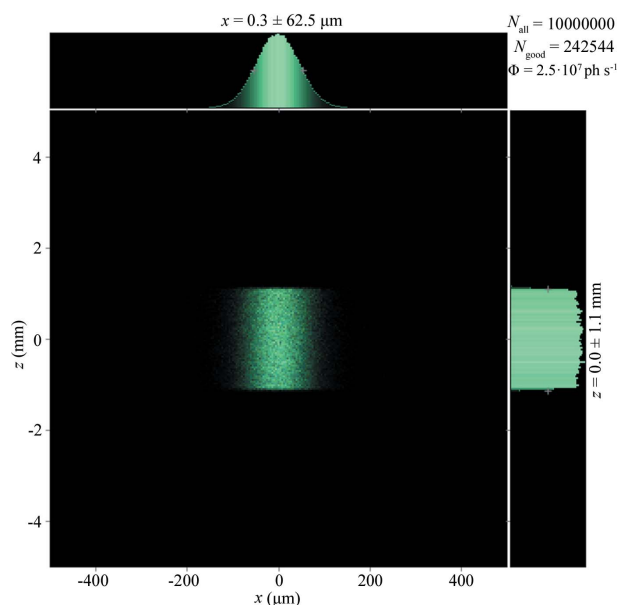

Figure 2
Two-dimensional distribution of the focused beam by *XRT*.

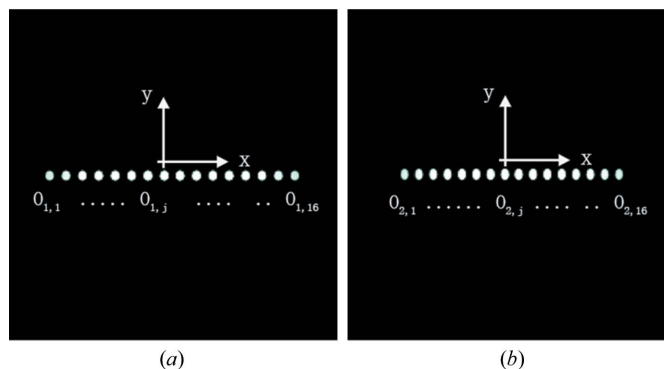

Figure 3
Images obtained by *XRT*. Distances from the first crystal were (a) 1.5 m and (b) 7.0 m.

The multi-hole array was defined by a row of round apertures. Sixteen round apertures divided the incident beam into 16 pencil beams. The central distance between the two adjacent apertures was set to 1 mm. Fig. 3 shows images obtained using *XRT*. The distances between the first crystal and the image screen were 1.5 m and 7.0 m. $O_{ij}(x_{ij}, y_{ij}, z_{ij})$ is the centroid coordinate of the j th spot in the i th image and z_{ij} is the distance between the i th image and the first crystal along the direction of the optical path. The center of each image could then be obtained from

$$O_i = \frac{\sum_{j=1}^n O_{ij}(x_{ij}, y_{ij}, z_{ij})}{n}, \quad (2)$$

where n is the quantity of round apertures in the multi-hole array. By using a simple coordinate transformation formula, the centroid coordinate of each image could be transformed into a global coordinate system,

$$O'_{ij} = O_{ij} - O_i, \quad (3)$$

where O'_{ij} is the centroid coordinate of the j th spot in the i th image in the global coordinate system (see Fig. 4). In the global coordinate system, by linking the centers of the spots from the same round aperture and extending the lines, we obtained the focusing information in a short measurement distance. In this case, the focal length was 45.6 m and the distance between the two outermost spots was 0.125 mm. These results were consistent with the above *XRT* simulation without the multi-hole array (45.6 m and 0.125 mm FWHM), indicating that this method can be used to measure the focus spot size in the horizontal plane, and the distance between the two outermost spots is approximately equal to the FWHM of the beam focus.

3. Experiment at beamline BL09B of SSRF

The measurements were performed at beamline BL09B of the SSRF; the setup is displayed in Fig. 5(a). The DLM configuration was used in this work and the sagittally bent crystals were the same size as those in the simulation. Before installation in the optical path, the sagittal radii of the two crystals were bent to about 1.2 m and were tested using optical

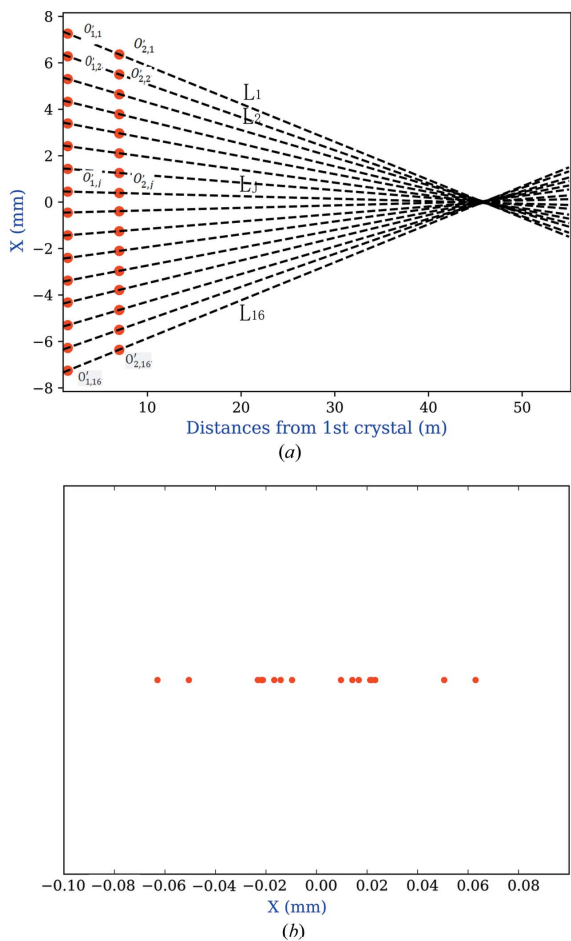

Figure 4
 (a) Simulation results of the focal distance by linking and extending the spot centroids from the same round aperture under a global coordinate system. (b) Horizontal distribution of the divided beams at the focused spot.

metrology. A multi-hole array made of 1.5 mm-thick tungsten was placed at the end window of the beamline vacuum pipe. Fig. 5(b) shows a photograph of the multi-hole array used in this work: 16 circular apertures are equally spaced on the multi-hole array; the diameters and spacings of the holes are 0.5 mm and 1 mm, respectively. A Ximea MH160XC CCD camera was placed downstream of the monochromator to record the reflected beam with various DLM–CCD distances. Due to the focusing properties of the sagittally bent crystal, the divided beams converge after reflection by the DLM. Fig. 6 shows the merged reflected images at various distances from the first crystal by moving the CCD camera along the optical path.

Using equations (2) and (3), the spots are transformed into a global coordinate system. By linking the centers of the reflected spots and making long extensions, the image distance and beam distribution at the focusing spot could be obtained (see Fig. 7). As shown in Fig. 7, the focal distance was about 53.5 m from the first monochromator crystal, and the horizontal distance between the outermost spots was about 0.37 mm. The focused beam size is clearly larger than the

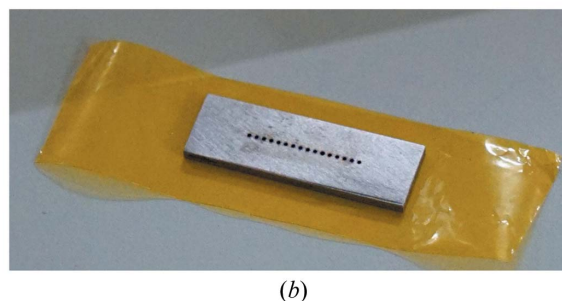
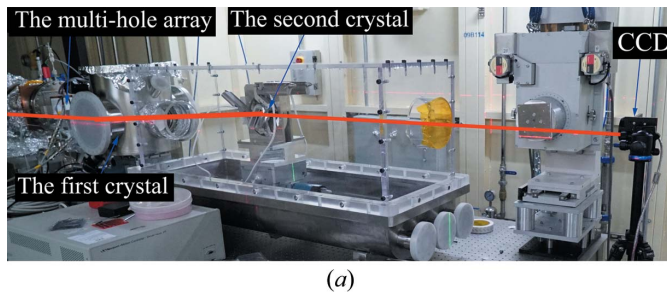

Figure 5
 (a) Photograph of the experimental setup at BL09B of SSRF (the red line is the optical path). (b) Photograph of the multi-hole array used in this experiment. The spacing between two adjacent circles is 1 mm.

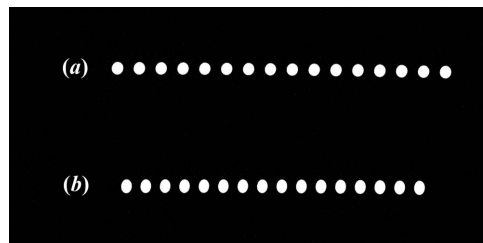

Figure 6
 Merged images of the reflected beam recorded by the CCD camera. The distances between the first crystal and the CCD are (a) 1.5 m and (b) 7.057 m.

theoretical beam size simulated above by *XRT*; this can be attributed to the imperfect surface shape of the crystals. From equation (1), we also determined the radii of the two sagittally bent crystals to be about 1.3 m, slightly different from the optical metrology result.

4. Discussion

The position coordinates of the multi-hole array were defined, as presented in Fig. 8. The direction of propagation along the ray represented the *y* axis, the horizontal direction represented the *x* axis and the vertical direction represented the *z* axis. If there are errors in the position of the multi-hole array, the final image fitting result may not be accurate, as shown by the following three exemplary cases:

Case 1: if there is a slight rotation around the *x* axis, the incident X-ray light will be divided into ellipses by the multi-hole array [Fig. 9(a)]. As we were only fitting the image using

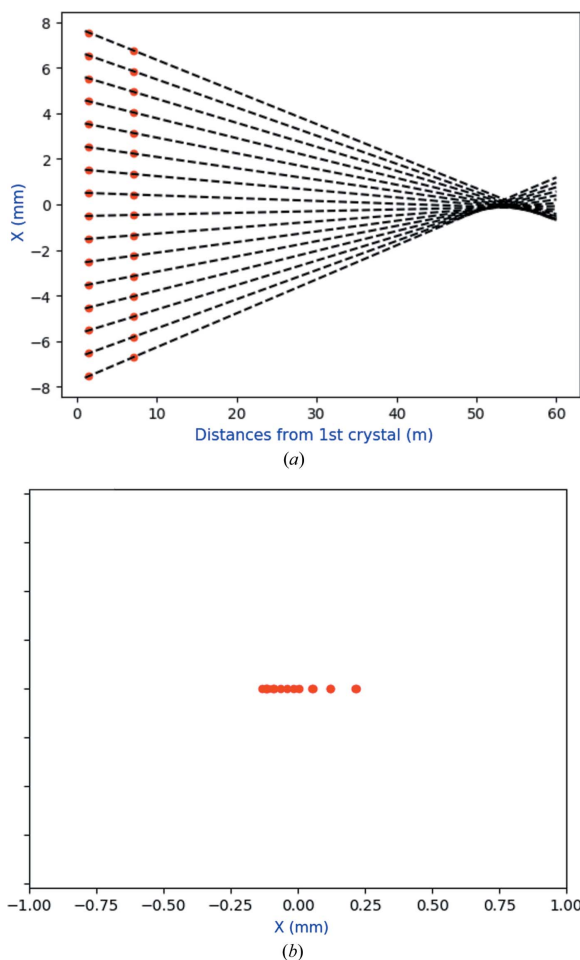

Figure 7
 (a) Extrapolated result. The focal distance is 53.5 m, and the focused beam size is about 0.37 mm. (b) Horizontal distribution of the focused beams at the focused spot.

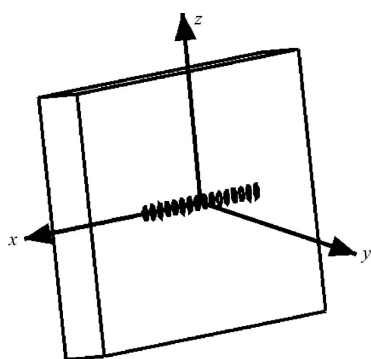

Figure 8
 Coordinate system of the multi-hole array.

the centers of the light spots, the x -axis rotation had no influence on the results.

Case 2: when there is a slight rotation around the y axis, the projection of the xz plane is at an angle to the x axis [Fig. 9(b)]. Here, the x -coordinates of the centers of the spots are actually smaller than those without rotation. As we were only fitting

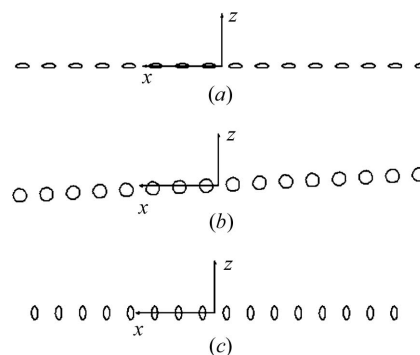

Figure 9
 Slight rotational position error around the (a) x axis, (b) y axis and (c) z axis for the multi-hole array.

the image using the centers of the light spots, the focal size of the fitting result will be smaller than the actual size.

Case 3: when there is a slight rotation about the z axis, the x coordinates of the centers of the spots through the multi-hole array are actually smaller than those without rotation [Fig. 9(c)]. This can be seen as a slightly smaller portion of the beam being used, so the focal size of the fitting result will not be changed.

In summary, only rotation about the y axis is important. In our experiment, we should be careful with the relative alignment of the multi-hole array, crystal and detector about the y axis.

5. Conclusions

We have provided a novel method for measuring the focusing characteristics of sagittally bent crystals using a multi-hole array. X-ray tracing simulations and experiments were performed to demonstrate this method. Our results suggest that the focusing characteristics can be easily and accurately obtained using this method, and the size of the focal point can be calculated releasing from the spacing limitation.

Acknowledgements

The authors would like to thank Dr Zhongliang Li from the Shanghai Synchrotron Radiation Facility for his kind help during the experiments.

Funding information

The following funding is acknowledged: National Nature Science Foundation of China (grant No. 11705226).

References

Klementiev, K. & Chernikov, R. (2014). *Proc. SPIE*, **9209**, 92090A.
 Shi, X., Ghose, S. & Dooryhee, E. (2013). *J. Synchrotron Rad.* **20**, 234–242.
 Zhong, Z., Kao, C. C., Siddons, D. P. & Hastings, J. B. (2001a). *J. Appl. Cryst.* **34**, 504–509.
 Zhong, Z., Kao, C. C., Siddons, D. P. & Hastings, J. B. (2001b). *J. Appl. Cryst.* **34**, 646–653.